

-SWEPT AWAY-

Description & Overview

Swept Away is a head-to-head robotics competition designed and scaled to be run in a classroom environment by a single teacher. This game provides a challenge for designers of all experience levels, and should result in exciting match play regardless of competitor skill.

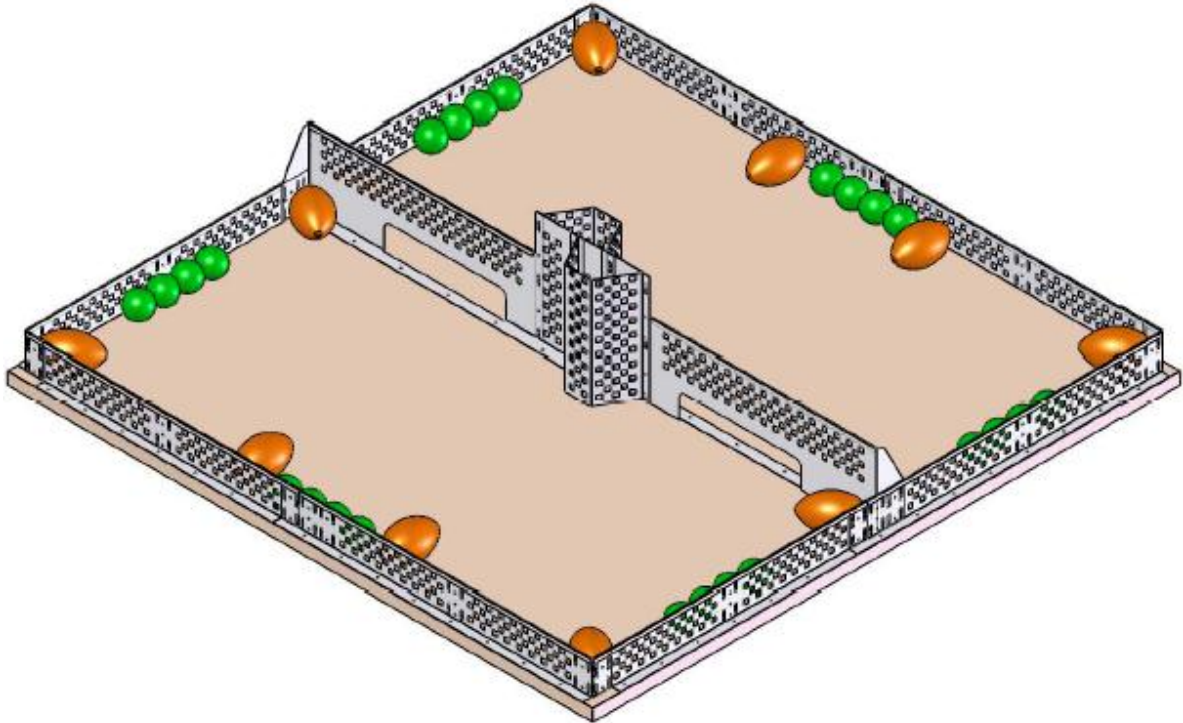

The game is played on an 8 ft x 8 ft field which is divided in half by a 12" tall wall. At the center of this wall are two 18" tall trapezoidal shaped goals, one on each side of the wall. There are also two 4" tall slots along the base of the wall.

One robot is placed on each side of the field with twelve small foam soccer balls and six foam footballs. Robots can dump footballs over the 12" tall wall. They can also roll soccer balls through the slots, dump them over the 12" wall or dump them into the 18" tall goals.

The object of the game is simple: get as many balls onto your opponent's side of the field as possible during a two minute match. At the end of the match referees will count the total balls on each side of the field. You get points based on what is on the opponent's side. (It doesn't matter if the balls started the match on that side, they still count!)

Every soccer ball on the opponent's side of the field is worth 1 point. Soccer balls placed in the 18" tall goal on the opponent's side of the field are worth 3 points. Footballs on the opponent's side of the field are worth 3 points.

If all the balls in play end up on one side of the field, the match immediately ends.

The team with all the balls on their side has been "SWEPT AWAY" and loses the match.

Scoring	
Soccer Ball	1 point
Soccer Ball in Goal	3 points
Football	3 points

** A team scores points by placing balls on their opponent's side of the wall!*

VEX Classroom Competition "Swept Away"

Game Rules

Field Setup

1. Matches are played on an 8 ft x 8 ft field which is divided in half by a 12" tall wall.
2. One robot is placed on each side of the divider wall at the start of every match.
 - a. Robots may be placed anywhere, as long as they are ENTIRELY on their side of the field, and NOT touching any balls.
 - b. At the start of the match no robot may be more than twelve inches (12") tall.
3. There are six (6) footballs placed on each side of the field, as shown.
4. There are twelve (12) soccer balls placed on each side of the field, as shown.

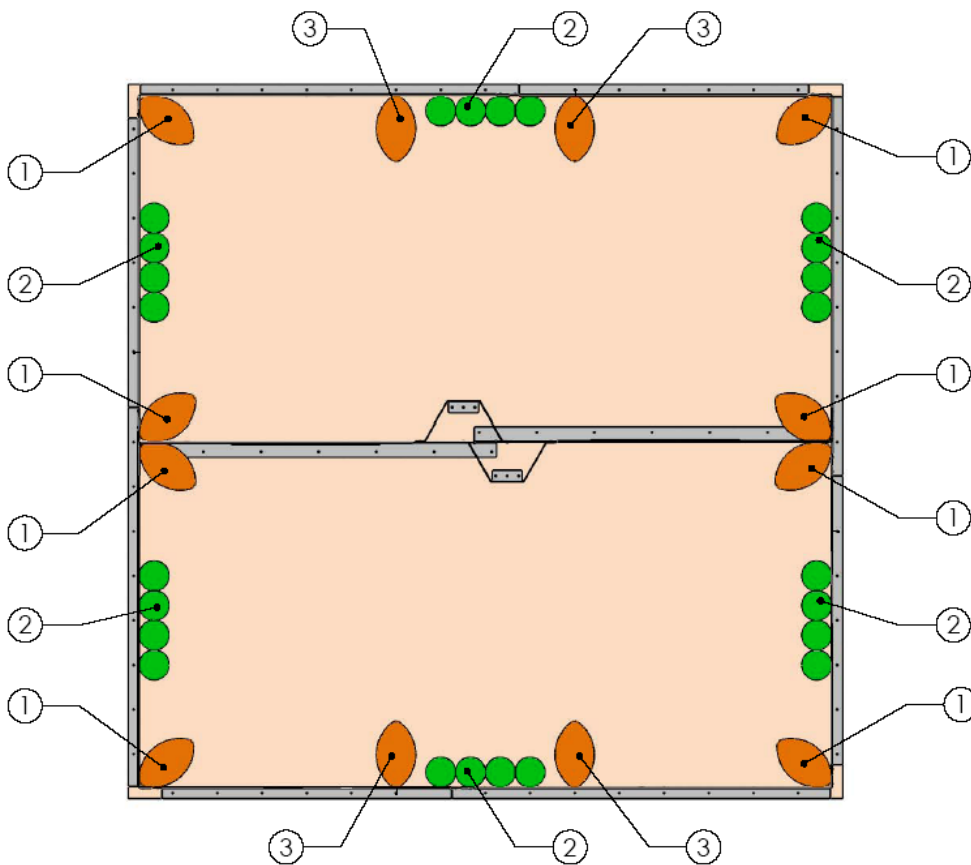

On each side of the field:

1. One (1) Football is placed in each of the four (4) corners.
2. Four (4) Soccer Balls are placed in a row centered on each of the three (3) outer walls.
3. Two (2) Footballs are placed 24" apart centered on the "back" wall.
Note: Use the mounting holes in the wall as reference points for placing these balls.

5. The field surface (that the robots drive on) is not specified. Any available surface is allowable.
 - a. *Recommended Surfaces: Linoleum, Concrete, Plywood, Foam Tiles, Low-pile Carpet*

VEX Classroom Competition “Swept Away”

Match Play



1. Two teams compete in each one vs. one match (each team will field one robot).
2. Matches are two minutes (2:00) long.
3. Robots are “Operator Controlled” the entire match; there is no Autonomous Robot Operation.
4. Any balls that exit the playing field will be returned to play as fast as possible by field personnel; these will be placed in about the same location they exited the field.
5. Robots are not permitted to touch the floor on the opponent’s side of the field.
 - a. Accidentally protruding over or under the dividing wall and incidentally touching the floor is ok.
 - b. Robot interaction over / under the wall is ok as long as neither robot touches the floor on the opposite side of the wall intentionally.
 - c. Protruding through the slot in the wall but not touching the floor intentionally is ok.
6. Team Members are not allowed to interact or interfere with the robots or balls in any way.
7. Robots are not allowed to intentionally attach to the field perimeter or divider wall.
8. Strategies aimed at intentionally damaging the field, balls, or opposing robots are illegal.

Match Scoring



- **A team receives one (1) point for every soccer ball on their opponent’s side of the field.**
- **A team receives three (3) points for every soccer ball in the goal on their opponent’s side of the field.**
- **A team receives three (3) points for every football on their opponent’s side of the field.**

1. Scoring is done at the end of the match, when all objects have come to rest.
2. A ball is only counted as being on one side of the field if it is ENTIRELY on one side of the center wall.
 - a. If the ball is partially on both sides, or if it is not obvious that it is entirely on one side, it does not count as being on either side.
3. A soccer ball is counted as being in a goal if *any part* of the soccer ball breaks the perimeter of the goal.
 - a. If it is hanging over the edge of the goal, it still counts.
 - b. If it is on top of the goal, but breaking the goal perimeter, it still counts.
 - c. If it is being held by a robot, but breaking the goal perimeter, it still counts.
 - d. If it is breaking the perimeter of both goals, it counts for both!
4. If a soccer ball is considered to be in a goal, it is worth only three (3) points, and does not get an additional point for being on the opponent’s side of the field.
5. Footballs do NOT receive points for being in a goal.
 - a. A football only counts for (3) points if it is entirely on one side of the field or the other (regardless of whether it is in a goal or not).
6. If at any point during the two-minute (2:00) match all the balls still in play (not already in a goal) end up on one side of the field, the match immediately ends, and the match will be scored at that time. The team with all the balls on their side has been “SWEPT AWAY” and loses the match.
 - a. Balls outside the field are still considered “in play” as they will be returned to the field.
 - i. Balls outside the field are considered to be scored on the side of the field where they exited the field. They will be returned to this same side.

VEX Classroom Competition “Swept Away”

Robot Construction

1. Robot construction is limited to the Robot Components from the VEX kits listed below.
 - a. The packaging, manuals, balls and other “non-robot” components from this kit are NOT allowed.
 - b. Teams can utilize the individual sub-components from these kits so long as they do not use more parts than are available on the list below or parts not found in any of the kits on the list.

VEX Classroom Competition – Construction List

Allowed Robot Components

- (1) Protobot Robot Kit
- (1) Booster Kit
- (1) Metal & Hardware Kit
- (1) Microcontroller
- (1) TX-RX Kit
- OR (1) VEXnet Joystick
- (1) Servo Kit
- (1) Motor Kit (5th motor)
- (1) 7.2V Robot Battery
- (1) Battery Mounting Straps
- (1) PWM Bundle
- (1) Limit Switch Kit
- (1) Bumper Switch Kit
- (1) Tank Tread Kit
- (1) Sprocket & Chain Kit
- (1) Advanced Gear Kit
- (1) Large Omni-Wheel Kit
- (1) Tank Tread Upgrade Kit
- (1) High Strength Gear Kit
- (1) High Strength Sprocket & Chain Kit
- (1) Linear Slide (2-pk)
- (1) Rack Gear Bracket (2-pk)
- (1) VEX Hinge (2-pk)
- (1) Rubber Band Pack
- (1) VEX Latex Tubing Pack (10-feet)

Note: The VEX Classroom Competition Team Bundles contain ALL the allowable components.

For more information on these VEX kits & components refer to www.VEXrobotics.com

2. Robots may only be controlled by (1) VEX Transmitter, OR (1) VEXnet Joystick.
3. Robots may use no more than (5) VEX Motors and no more than (1) VEX Servo.
4. Robots may use unlimited of the following VEX components: screws, nuts, bearings, bearing rivets, collars, washers, spacers, and zip ties.
5. Parts may not be attached in any way not provided as part of the VEX Robotics Design System
 - a. Example – It is illegal to glue, weld, solder, or to stick parts together with chewing gum.
6. VEX Electronics may not be modified in any way.
7. No robot may be more than twelve inches (12”) tall at the start of any match.
 - a. The robot may expand above this limit after the match has begun.
 - b. There is no limit on the robot footprint as long as it is less than 12” tall.
8. We encourage teams to show individuality by decorating their robots. As such, teams may add non-functional decorations provided that these do not affect the robot performance in any significant way or affect the outcome of the match.

VEX Classroom Competition “Swept Away”

Tournament Play

1. Teams will be ranked using a series of qualifying matches.
 - a. Ideally these matches will be played as a round-robin tournament where each team plays every other team at least once; otherwise matchups should be randomly chosen.
2. Teams are ranked based on their number of wins.
 - a. If more than one team has the same number of wins, these teams are ranked based on their number of ties.
 - b. If more than one team has the same number of wins and ties, these teams are ranked based on their highest score.
 - c. If these teams also have the same highest score, they are then ranked by their next highest score, then their next, then their next, until the tie is broken.
 - d. If all their scores are the also same, the ranking will be determined with a playoff match between the two teams. The team that wins is then ranked higher.
3. The top ranked teams will play in an elimination tournament to determine the winner.
 - a. Two teams play in each series of the playoffs; the first team to win two matches wins the series and advances to the next round of the playoffs.
 - b. The tournament structure will vary depending on the number of teams participating.
 - c. Here is a sample tournament bracket:

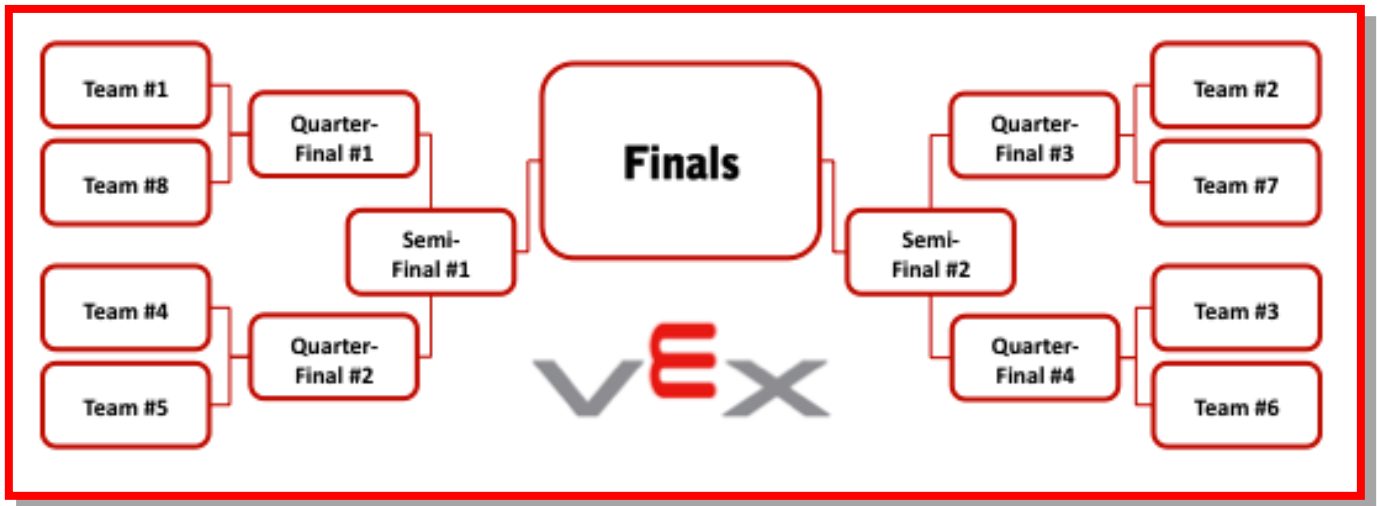

VEX Classroom Competition “Swept Away”

Swept Away Field

Swept Away is played on an 8 ft x 8 ft field which is divided in half by a 12” tall wall. At the center of this wall are two 18” tall trapezoidal shaped goals, one on each side of the wall. There are also two 4” tall slots along the base of the wall. There are twelve (12) orange foam footballs and twenty-four (24) green foam 4” soccer balls in play on the field.

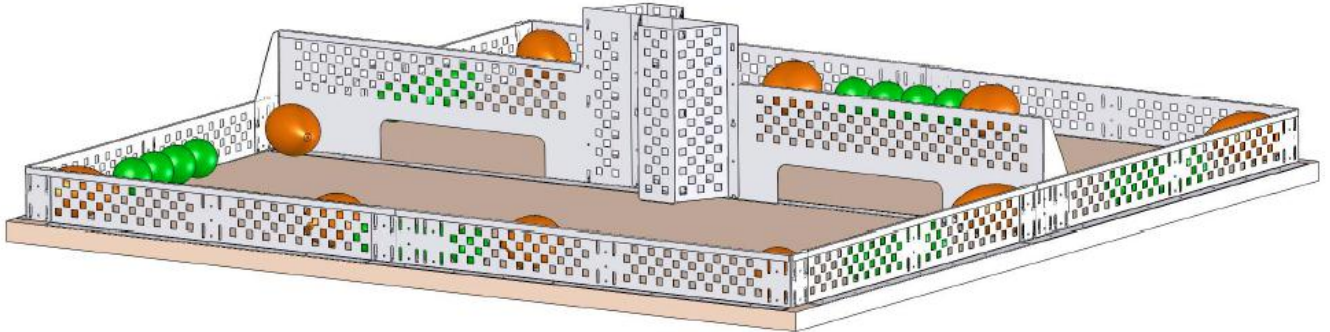

The VEX Classroom Competition Field Kit (278-1004) available at VEXrobotics.com includes the entire official Swept Away field, including the perimeter, field wall, goals, and all balls.

This official field was designed specifically for implementation in a classroom environment. Its robust sheet-metal construction can handle all the rigors of competition. The field requires NO tools for assembly and can be fully set up or taken apart for storage in less than five minutes.

Critical Field Specifications

Perimeter Dimensions

The field is surrounded by a 5.59 inch tall sheet metal perimeter. This perimeter is constructed of (8) brackets in a square configuration. The inside of the field measures 92.94" x 92.94".

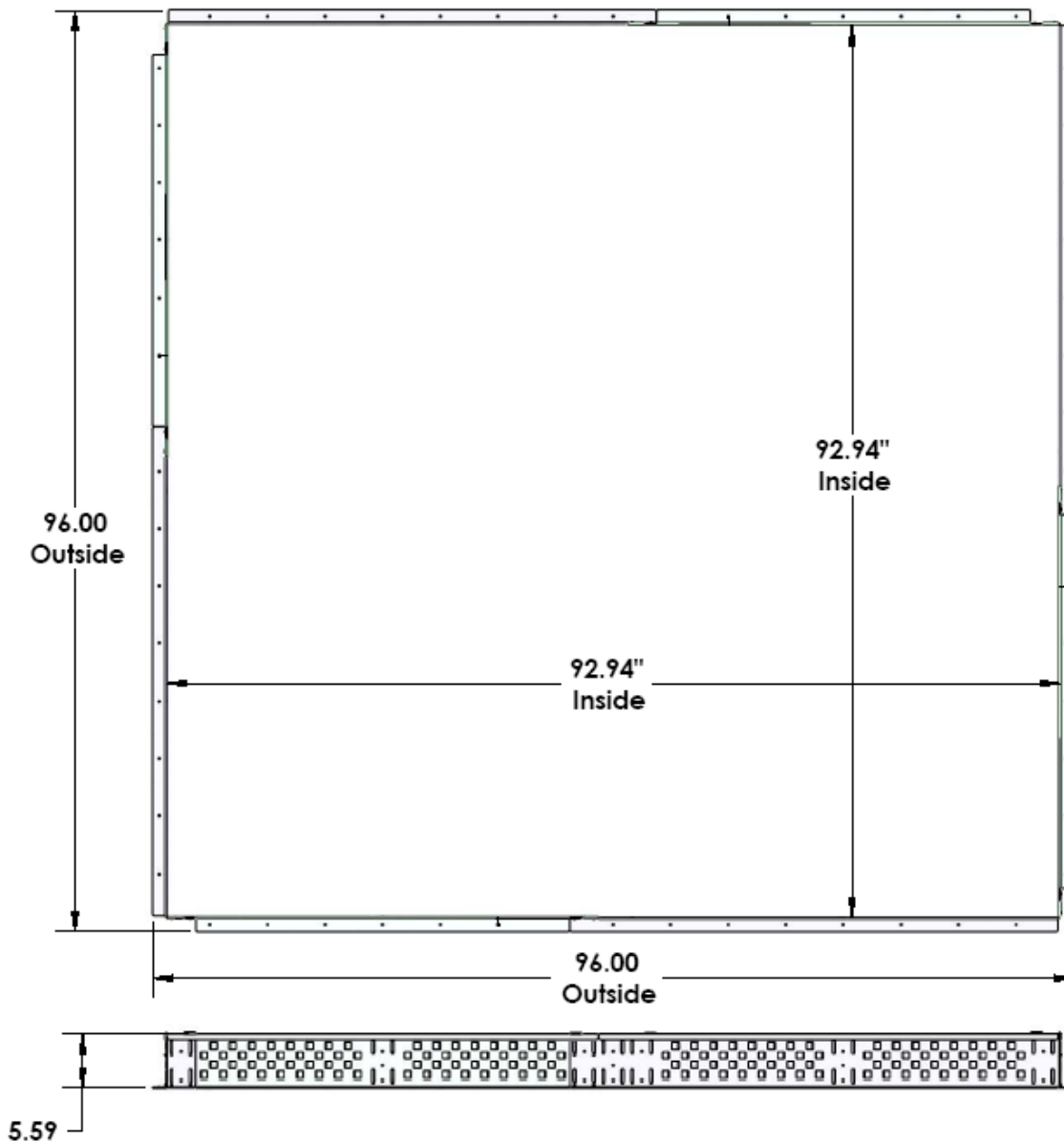

The outside of the field measures 96" x 96" so it can be mounted on two 4 ft x 8 ft pieces of plywood if desired.

Critical Field Specifications cont.

Wall & Goal Dimensions

The center wall dividing the field is 12.18" tall, and stretches across the entire field (92.94") directly down the center. There are two 20" wide x 4.16" tall slots in the wall for soccer balls to roll through.

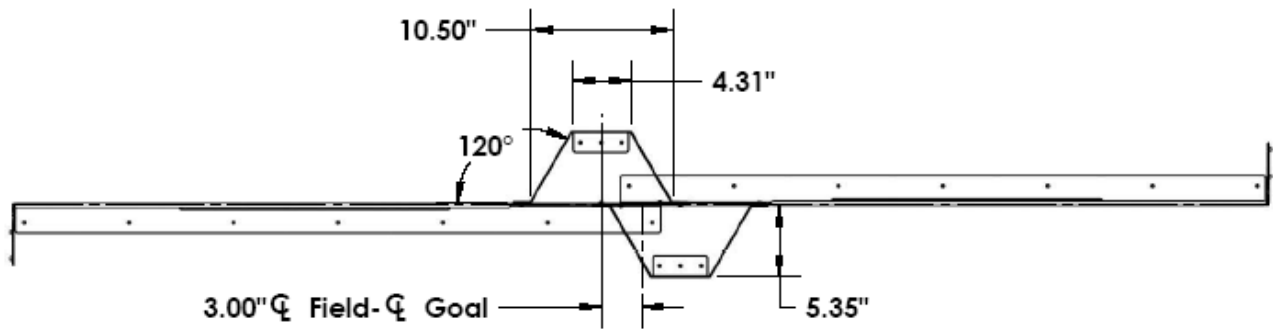
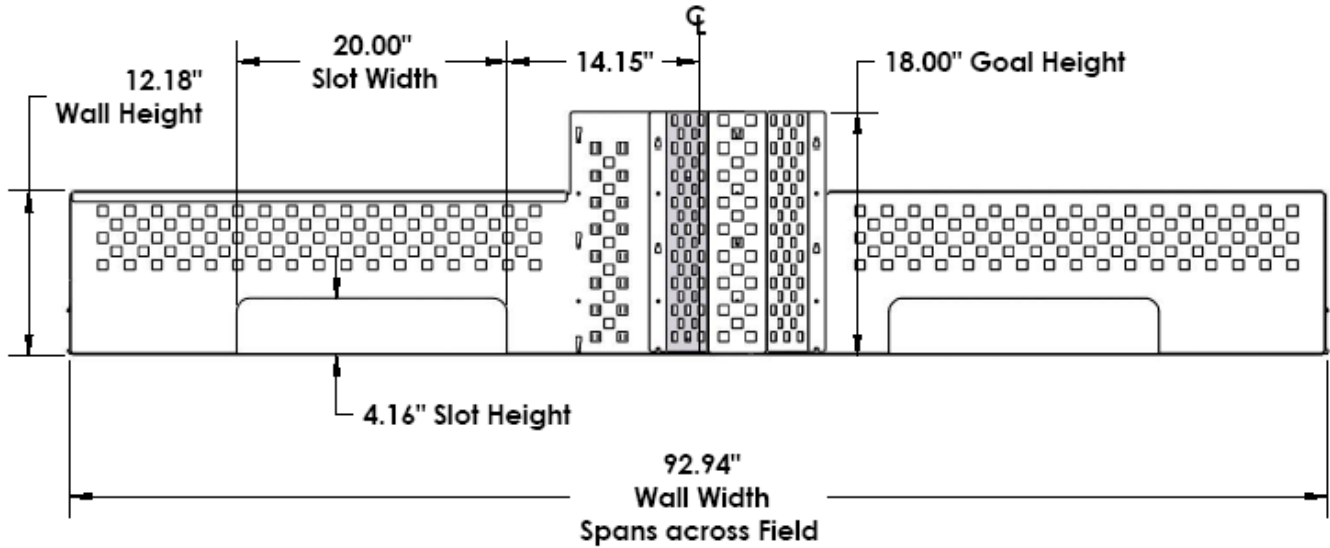

In the center of the wall there are two 18" tall goals. These goals are 10.5" wide at the wall, 4.31" wide at the tip, and project out from the wall 5.35". The goals are 3" offset from the center of the field.

Critical Field Specifications cont.

Ball Dimensions

Green Soccer Balls:

Size – approximately 4.0" in diameter
Weight – approximately 0.125 lbs



Orange Footballs:

Width – approximately 5.25" wide
Length – approximately 9.0" long
Weight – approximately 0.4 lbs



Unofficial Field Construction

The official field is *NOT* needed to play Swept Away.

There are a number of methods to build a "close enough" field to play the game. It is also possible to build stand-in objects for practice. (For example, it is possible to use a piece of cardboard 12" tall to simulate the height of the wall.)

A full field perimeter can easily be constructed out of 8-foot long 2x6 boards. The wall can be mocked up from plywood and 2x4 boards.

Swept Away can also be played with different game objects. If footballs and soccer balls matching the official Swept Away game objects are not available, it is possible to play the game with something else. (Obviously in this case the robots might not be able to play with official game objects, if they were designed for something else).

Field Assembly Instructions

The official Swept Away Field consists of four different types of metal pieces:

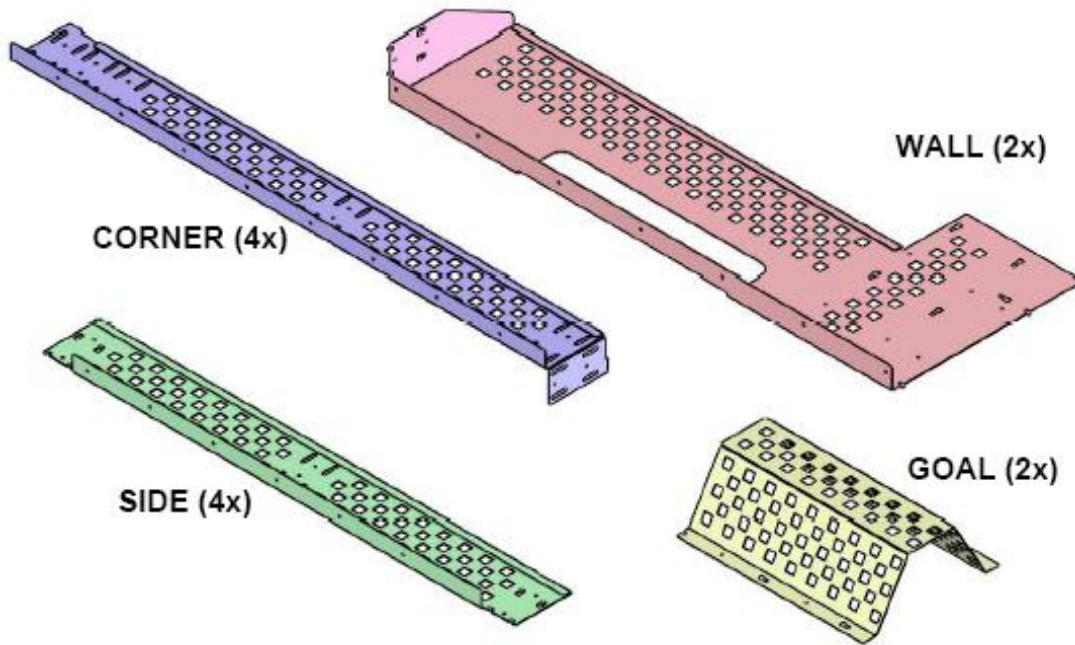

1. The first step to assembling the field is to connect a SIDE piece with a CORNER piece as shown. Insert all four (4) hooks on the SIDE into the slots on the CORNER. Then, slide the SIDE down over the CORNER such that all four hooks are seated at the bottom of their slots.

Note: This is the standard method of connection and will be reused at all field joints.

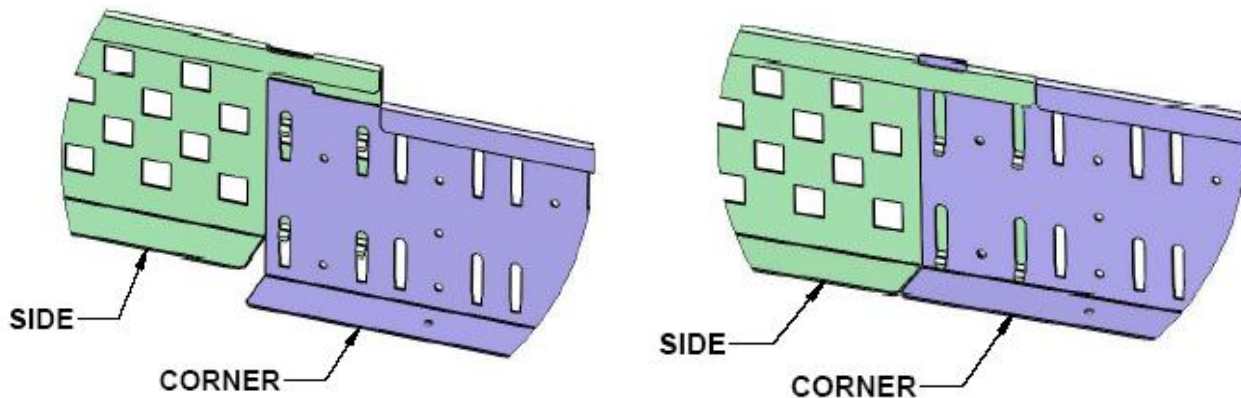

2. Repeat Step 1 for four (4) identical assemblies.

Field Assembly Instructions cont.

3. Connect two (2) of the assemblies together as shown below. They should hook together in the same manner described in Step 1. The SIDE piece of one assembly should connect to the CORNER piece of the other assembly.

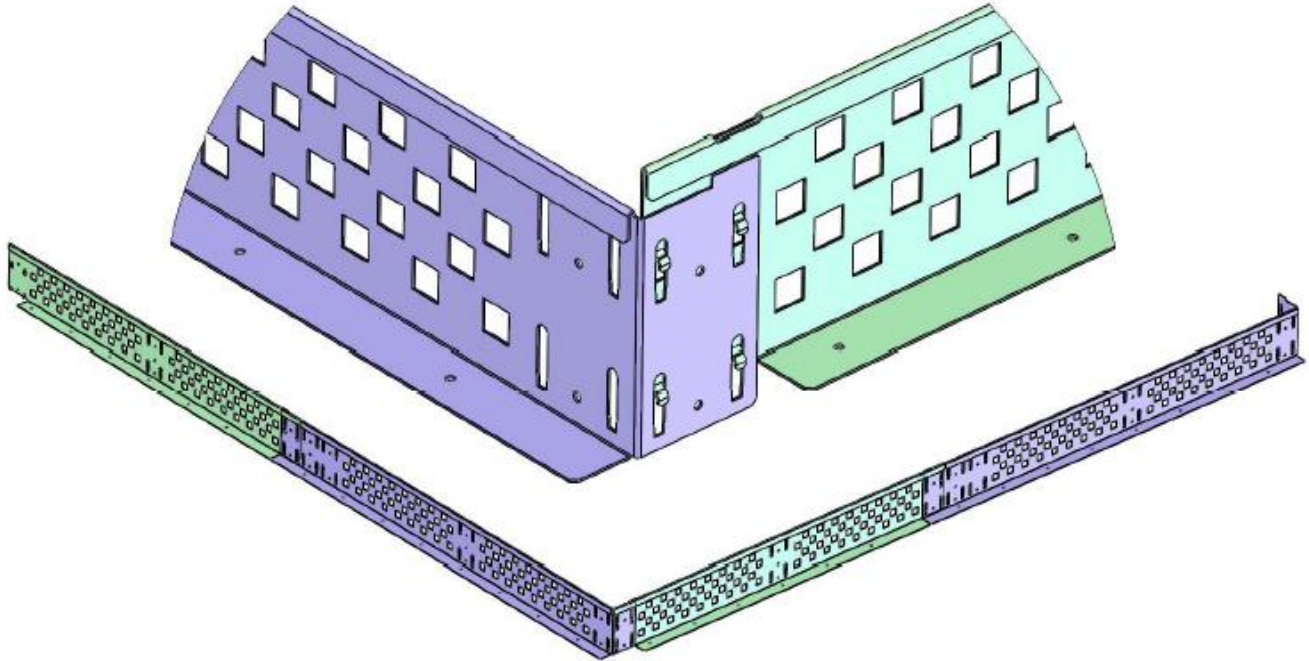

4. Repeat Step 3
5. Connect the assemblies from Step 3 & Step 4 together to complete the field perimeter.

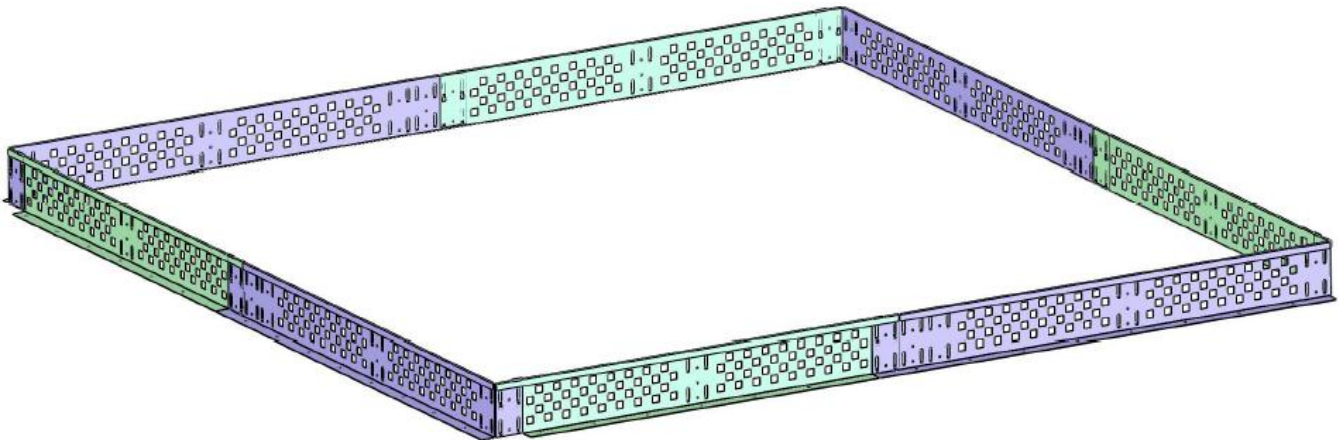

Field Assembly Instructions cont.

6. Attach the two (2) WALL pieces together as shown. Note, each WALL piece has two (2) hooks to engage in two (2) slots on the other wall piece. Ensure that all four (4) hooks are fully engaged.

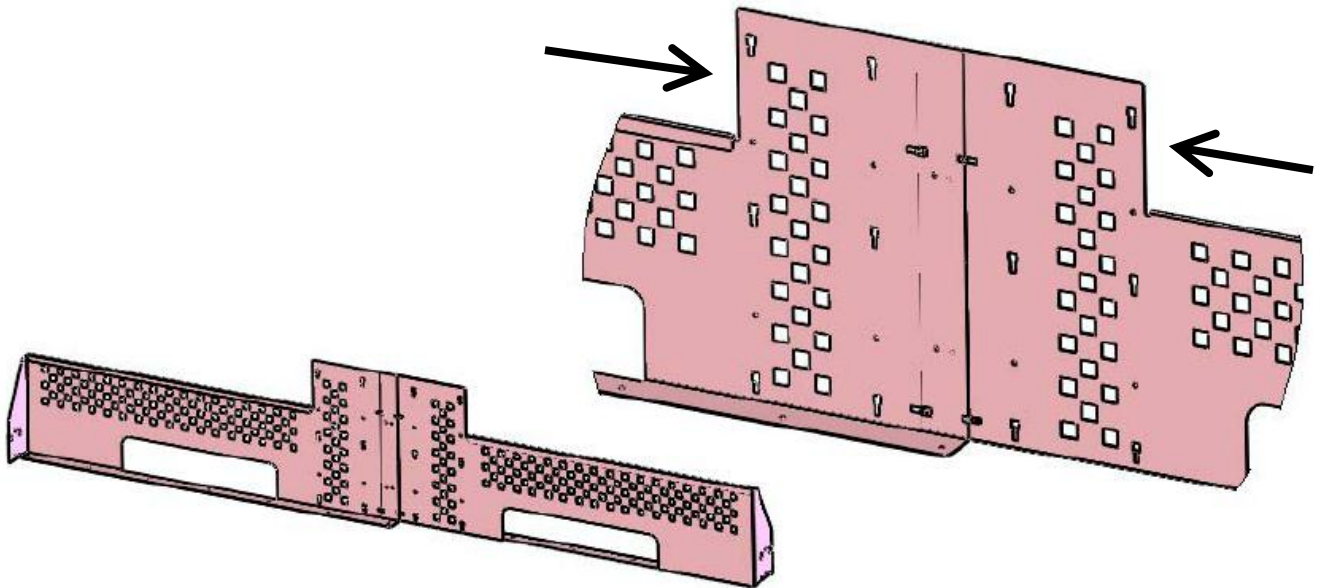

7. Install the wall assembly from Step 6 onto the field perimeter assembly from Step 5 as shown. The wall assembly has four hooks on each end which will grab onto matching slots on the field perimeter. Ensure the wall assembly is centered such that it divides the field in half.

There are (3x) sets of mounting slots near the center of the field. Ensure the wall is installed in the correct set, (furthest from where the SIDE and CORNER pieces are joined) as pointed out by the arrow in the image below.

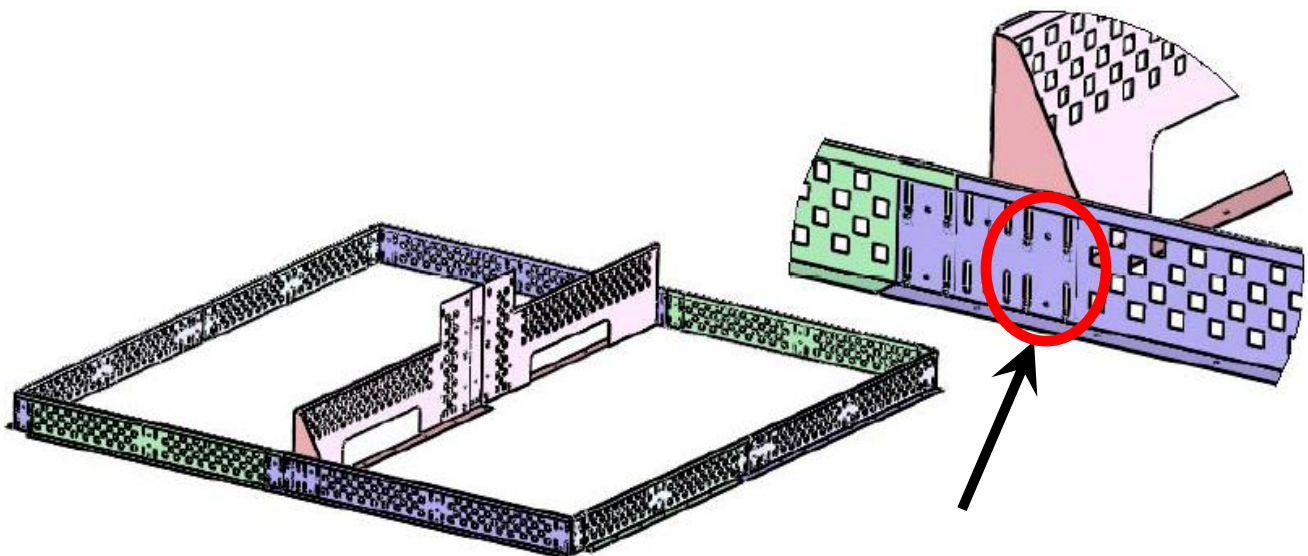

Field Assembly Instructions cont.

8. Attach the two (2) GOAL pieces onto the wall assembly as shown. Place the goals such that if you are looking at the center wall, the goal on your side of the wall is toward the right. Ensure that all six (6) hooks on each GOAL piece engage fully into their mounting slots.

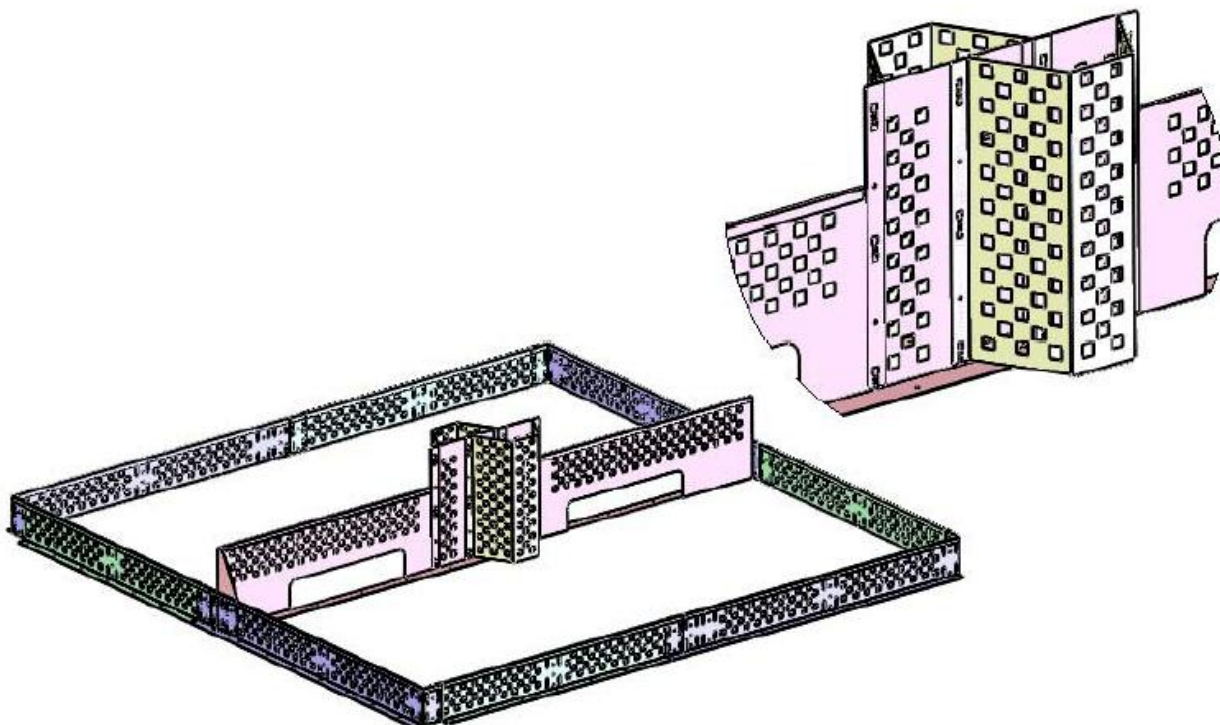

9. Place twelve (12) Orange Footballs and (24) Green Soccer Balls on the field as shown.

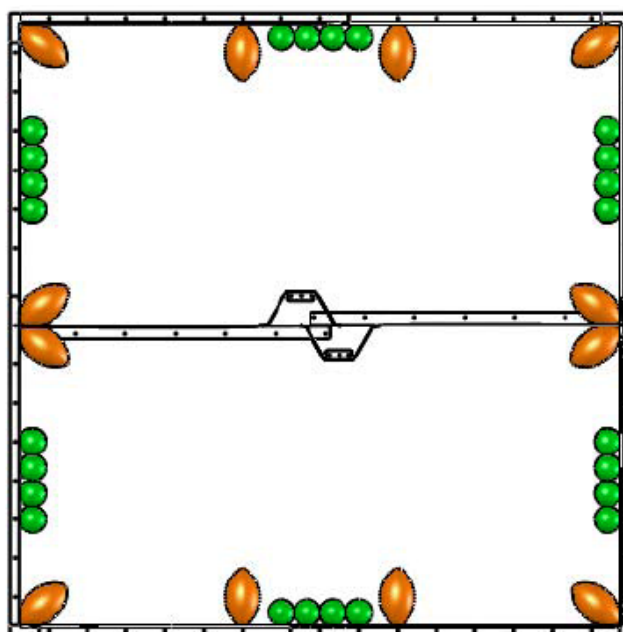

Additional Field Options

Although the VEX Classroom Competition field perimeter snaps together as a tool-less assembly there are 0.205” diameter holes in all of the pieces. If a user plans on leaving the field assembled for an extended period of time, standard VEX screws and nuts (#8-32) can be used to bolt the field components together.

The field is also designed to fit on top of two (2) 4 ft x 8 ft pieces of plywood laid side by side. All of the field brackets have bottom flanges with holes in them; these holes allow users to screw the field down onto the plywood.

Additional Game Options

This document provides a detailed foundation set of rules and specifications, it is a “recipe” for a Swept Away competition; however this is not the only correct recipe. The VEX Classroom Competition and the Swept Away game are specifically designed to scale to the needs and circumstances of participants. It is easy to modify rules to tweak the way the game is played.

Game Rules Modifications

The Swept Away game itself can be changed to suit your needs. A few possible adjustments are described below, but these are only a small sample of what is possible:

- Add an autonomous period at the beginning of each match where human operators have no control over their robots.
- Remove the Goals from the center wall.
- Block the slots in the wall.
- Only use Footballs OR Only use Soccer Balls.
- Use different game objects.
- Increase the height of the wall.
- Change the point values for the balls.
- Play each match 2 vs. 2
- Modify the seeding or tournament structure.
- Etc...

As long as the game rules are adequately described to teams ahead of time, a tournament can modify almost any aspect of the competition. Larger and more wide-spread tournaments & competitions should post any changes they are making to this basic set of rules so teams know how that competition will differ from what they are used to; in a single classroom environment or a smaller scale competition, this is not as important.

Major deviations from the “foundation” set of rules and field specifications listed above may have undesired results on the game play, but that is just part of the fun!

Robot Construction Rules Modifications

As long as some key robot construction rules are in place it is possible to modify the rules to suit your needs and circumstances. It is recommended that some limit be placed on the quantity of motors & servos allowed, as well as the control system and battery used. Beyond that there are a number of ways to adjust the rules (modifying the maximum robot starting size, etc).

One of the most common ways to modify the rules is to scale up or down the list of allowable robot parts. There are very successful competitions that only allow teams to use a single Protobot kit for robot construction, and there are very successful competitions that allow their teams to custom fabricate whatever parts they want; there is a broad spectrum of options. It is important for each competition to be tailored to best suit its participants.

Swept Away Score Cards

MATCH NUMBER:	Winner:
<p>Team 1:</p> <p>Soccer Balls on Opposite side of the Wall: <input style="width: 50px; height: 30px;" type="text"/> X 1 = <input style="width: 50px; height: 30px;" type="text"/></p> <p style="text-align: center;">+</p> <p>Soccer Balls in Opposite side Goal: <input style="width: 50px; height: 30px;" type="text"/> X 3 = <input style="width: 50px; height: 30px;" type="text"/></p> <p style="text-align: center;">+</p> <p>Footballs on Opposite side of the Wall: <input style="width: 50px; height: 30px;" type="text"/> X 3 = <input style="width: 50px; height: 30px;" type="text"/></p> <p style="text-align: center;">=</p> <p>Team 1 TOTAL SCORE = <input style="width: 50px; height: 30px;" type="text"/></p>	<p>Team 2:</p> <p>Soccer Balls on Opposite side of the Wall: <input style="width: 50px; height: 30px;" type="text"/> X 1 = <input style="width: 50px; height: 30px;" type="text"/></p> <p style="text-align: center;">+</p> <p>Soccer Balls in Opposite side Goal: <input style="width: 50px; height: 30px;" type="text"/> X 3 = <input style="width: 50px; height: 30px;" type="text"/></p> <p style="text-align: center;">+</p> <p>Footballs on Opposite side of the Wall: <input style="width: 50px; height: 30px;" type="text"/> X 3 = <input style="width: 50px; height: 30px;" type="text"/></p> <p style="text-align: center;">=</p> <p>Team 2 TOTAL SCORE = <input style="width: 50px; height: 30px;" type="text"/></p>

MATCH NUMBER:	Winner:
<p>Team 1:</p> <p>Soccer Balls on Opposite side of the Wall: <input style="width: 50px; height: 30px;" type="text"/> X 1 = <input style="width: 50px; height: 30px;" type="text"/></p> <p style="text-align: center;">+</p> <p>Soccer Balls in Opposite side Goal: <input style="width: 50px; height: 30px;" type="text"/> X 3 = <input style="width: 50px; height: 30px;" type="text"/></p> <p style="text-align: center;">+</p> <p>Footballs on Opposite side of the Wall: <input style="width: 50px; height: 30px;" type="text"/> X 3 = <input style="width: 50px; height: 30px;" type="text"/></p> <p style="text-align: center;">=</p> <p>Team 1 TOTAL SCORE = <input style="width: 50px; height: 30px;" type="text"/></p>	<p>Team 2:</p> <p>Soccer Balls on Opposite side of the Wall: <input style="width: 50px; height: 30px;" type="text"/> X 1 = <input style="width: 50px; height: 30px;" type="text"/></p> <p style="text-align: center;">+</p> <p>Soccer Balls in Opposite side Goal: <input style="width: 50px; height: 30px;" type="text"/> X 3 = <input style="width: 50px; height: 30px;" type="text"/></p> <p style="text-align: center;">+</p> <p>Footballs on Opposite side of the Wall: <input style="width: 50px; height: 30px;" type="text"/> X 3 = <input style="width: 50px; height: 30px;" type="text"/></p> <p style="text-align: center;">=</p> <p>Team 2 TOTAL SCORE = <input style="width: 50px; height: 30px;" type="text"/></p>